



**INTRA-ORAL X-RAY SYSTEM**  
**IRIX 70**

**USER'S MANUAL**

Trophy constantly strives to improve its products and, therefore, reserves the right to deliver, without prior notice, machines whose characteristics differ from those described here; nonetheless, these machines are still guaranteed to comply with regulations in force. All rights reserved.

## INTRODUCTION

You have just purchased a TROPHY intra-oral X-ray system (IRIX 70). We congratulate you on your choice, and are sure you will be fully satisfied with its use and diagnostic capabilities.

TROPHY radiology units offer high quality and advanced technology.

We recommend reading this manual carefully before using your unit, to become familiar with its operation and make the most of its performance.

Keep this manual in a safe place so that you can easily refer to it in the future.

Thank you for placing your confidence in TROPHY.

## PROTECTION AGAINST X-RAYS

X-rays are not innocuous and can be dangerous if not used appropriately. You must, therefore, follow the instructions in this manual.

Radiology units manufactured by TROPHY comply with the strictest safety standards in force throughout the world (IEC 601 in Europe, CSA in Canada, UL in USA, etc.). They guarantee optimum protection against radiation risks.

Nonetheless, you are handling a radiology unit specifically designed to generate X-rays to allow medical diagnosis on a film or using RVG (a digital dental imaging system). Consequently, despite all the TROPHY know-how and the inherent safety of our equipment, we recommend you using conventional commercially-available equipment to protect yourself and your patients against radiation risk.

In the same spirit, the room which houses your radiology unit must comply with all official regulations applicable to protection against radiation.

Your distributor will be pleased to help you with the initial use of your unit and to answer any subsequent questions you may have.

It is mandatory to use this X-ray unit with its beam limiting device.

The signs "Warning" and "Ionising radiation" fixed to the front panel of the control unit mean **"WARNING IONISING RADIATION"**.



## WARRANTY CONDITIONS

It is the responsibility of the user to comply with current legislation concerning installation and operation of the equipment.

In the event of incorrect use or defective maintenance not complying with the recommended scheme, TROPHY or its representative shall not be liable for any deficiencies, physical damage, personal injuries or non conformity that may occur as a result.

The equipment must not be used if electrical, mechanical or radiation protection components are defective, or if the operations stipulated by the maintenance program have not been carried out.

Only TROPHY or third parties duly authorized by TROPHY may carry out modifications or add extensions to the installation and equipment.

Such modifications shall always be carried out in compliance with the regulations in force in the country of operation, and in compliance with normal trade practice.

If the power supply characteristics do not comply with the recommendations given in the Installation and Maintenance Manual section 4 Chapter II "Prior to Installation", the *IRIX 70* unit will not be able to provide maximum performance, and it will not be possible to guarantee normal operation.

You can obtain a complete technical file about the *IRIX 70* unit by simply requesting it from TROPHY.

## TRANSPORTATION CONDITIONS

The goods are transported at the consignee's risk.

Any disputes as to losses or damage occurring during transportation must be stated in the presence of the haulier upon delivery, and must be noted on the delivery slip.

Under no circumstances shall packaging materials manufactured by TROPHY be used for any other purposes than transportation.

# CONTENTS

<b>DESCRIPTION OF THE SYSTEM</b> . . . . .	1
<b>USE OF THE UNIT</b> . . . . .	2
<b>I. PATIENT POSITIONING</b> . . . . .	2
FIGURE 1: PATIENT POSITIONING . . . . .	2
<b>II. GENERATOR POSITIONING</b> . . . . .	2
FIGURE 2: PARALLELING TECHNIQUE . . . . .	2
FIGURE 3: BISSECTING TECHNIQUE . . . . .	2
<b>III. FILM POSITIONING</b> . . . . .	3
FIGURE 4: FILM POSITIONING (Bisecting technique) . . . . .	3
FIGURE 5: FILM POSITIONING (Paralleling technique) . . . . .	4
FIGURE 6: FILM POSITIONING (Occlusal pictures) . . . . .	5
FIGURE 7: FILM POSITIONING (Bitewing pictures) . . . . .	5
FIGURE 8: CCX-Digital TIMER . . . . .	6
<b>IV. PREPARING THE TIMER AND TAKING AN X-RAY</b> . . . . .	7
<b>V. ADDITIONAL CHARACTERISTICS OF THE TIMER</b> . . . . .	8
<b>FILM DEVELOPMENT</b> . . . . .	9
<b>I. MANUAL DEVELOPMENT</b> . . . . .	9
<b>II. AUTOMATIC DEVELOPMENT</b> . . . . .	9
<b>III. MAIN REASONS FOR POOR X-RAYS</b> . . . . .	9
<b>TECHNICAL CHARACTERISTICS</b> . . . . .	10
<b>I. TECHNICAL CHARACTERISTICS ACCORDING TO IEC STANDARD 601-2-7</b> . . . . .	10
<b>II. MAIN CHARACTERISTICS OF THE X-RAY GENERATOR</b> according to standard EN 60601-2-28 . . . . .	11
<b>III. EXPOSURE TIMES FOR DIFFERENT PROGRAMS</b> (film type 6 and nominal voltage) . . . . .	13
<b>IV. CHOICE OF FILM TYPE</b> . . . . .	14
<b>V. FILM TYPE CORRECTION FACTORS</b> . . . . .	14
<b>PREVENTIVE MAINTENANCE</b> . . . . .	16
<b>I. FIRST LEVEL MAINTENANCE - YEARLY</b> . . . . .	16
<b>II. SECOND LEVEL MAINTENANCE - EVERY TWO YEARS</b> . . . . .	18
<b>III. FUSES EXCHANGE</b> . . . . .	21

Original language of document: FRENCH



## DESCRIPTION OF THE SYSTEM

---

Your intra-oral X-ray system includes:

- An IRIX 70 generator which includes:
  - > an oil bath transformer and X-ray tube
  - > an aluminum filter which improves the beam quality and reduces the radiation dose received by the patient
  - > a beam limiting device which restricts the beam diameter to approx. 6 cm on the skin and maintains a distance of 20 cm between the X-ray focal spot and the skin
  - > an angular scale and a handle to facilitate positioning
  
- A CCX-Digital timer which includes:
  - > an anatomy selector and digital display of exposure time
  - > automatic compensation for mains voltage variations ( $\pm 20\%$ )
  - > a built-in microprocessor test, runs each time the unit is switched on
  - > an alarm triggered by any incorrect operation
  - > an "RVG" button which automatically adjusts the exposure time if you use an RVG (RadioVisioGraphy)

- A scissor arm:

The scissor arm allows the generator head to be quickly and accurately positioned.

It can be mounted:

- on the wall, with an extension arm of 11-13/16, 23-5/8 or 31-1/2 in. (30, 60, or 80 cm)
- on a mobile stand
- on a floor-mounted column, with an extension arm of 11-13/16 in. (30 cm)
- from the ceiling
- on the dental unit, with an extension arm of 11-13/16 in. (30 cm)

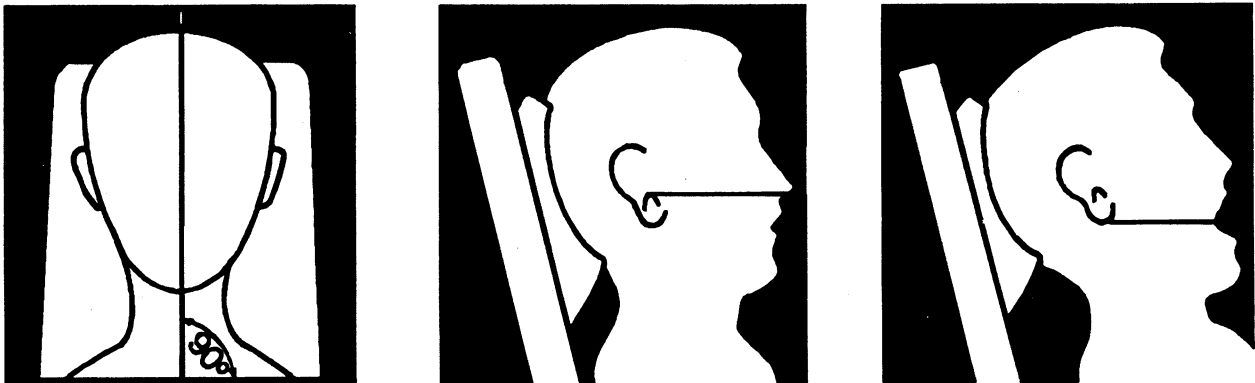
**Note:** *Some models have a standard arm instead of the scissor arm. This does not change their operation.*

# USE OF THE UNIT

## I. PATIENT POSITIONING

The patient should preferably be seated with the sagittal plane vertical (figure 1).

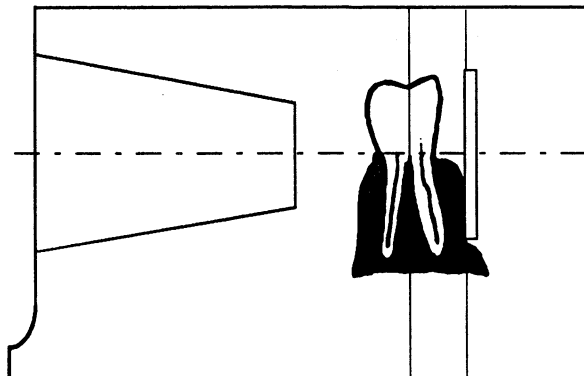
- > Radiography of the upper maxillary: the nose-ear plane must be horizontal
- > Radiography of the lower maxillary: the occlusal plane must be horizontal



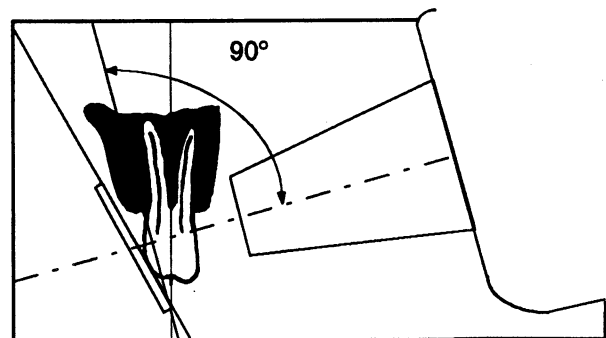
**FIGURE 1: PATIENT POSITIONING**

## II. GENERATOR POSITIONING

The scissor arm allows the generator to be accurately positioned for any type of exposure. The beam limiting device maintains a distance of at least 20 cm between the focal spot and the skin. Subsequently, either the paralleling technique (figure 2), or the bisecting technique (figure 3) can be used.



**FIGURE 2: PARALLELING TECHNIQUE**



**FIGURE 3: BISSECTING TECHNIQUE**

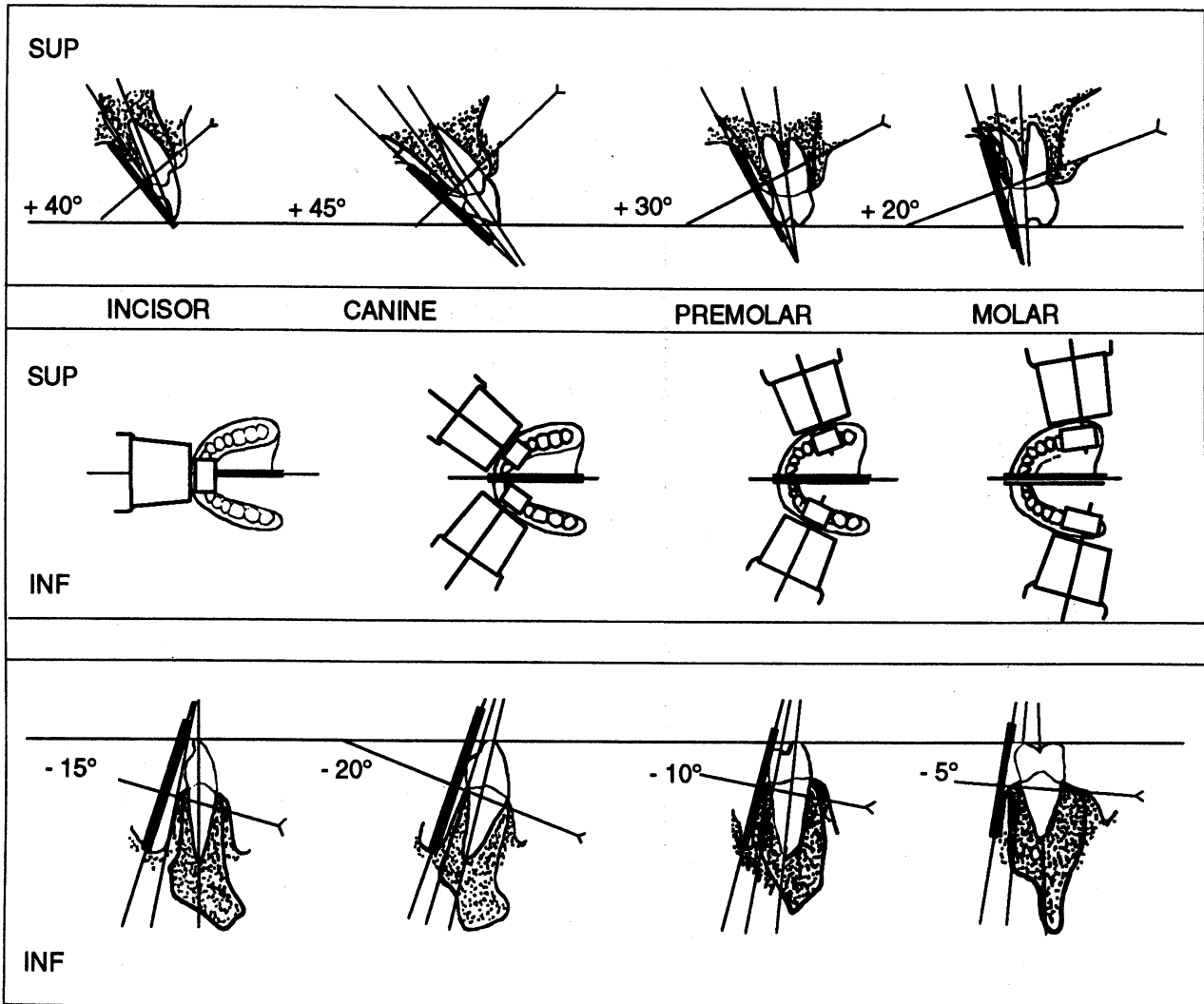


### III. FILM POSITIONING

Place the face of the film with no label against the area to be examined.

□ **Bisecting technique:**

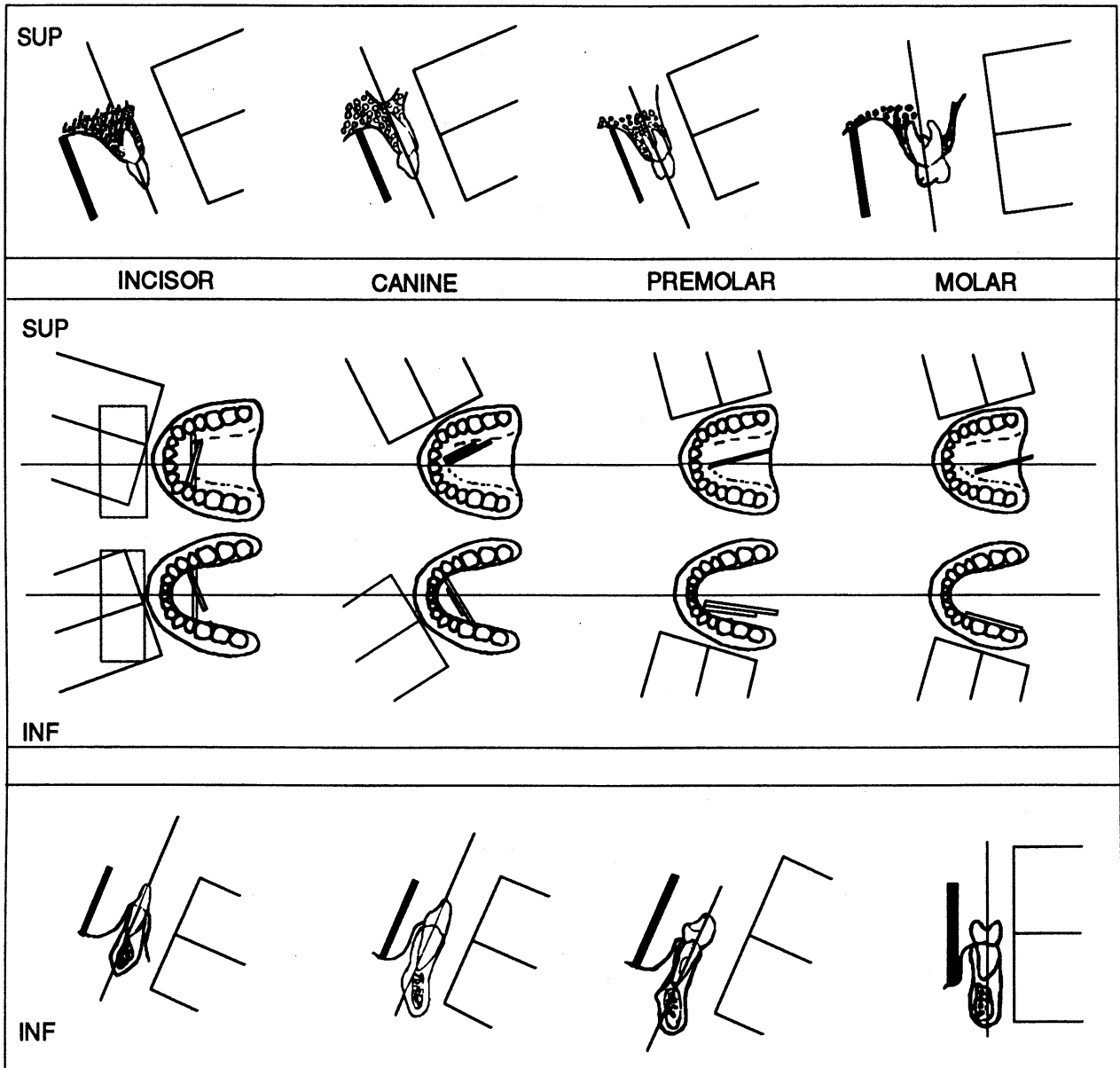
Place the film and generator as shown in figure 4 (the beam is perpendicular to the line which bisects the angle between the tooth and film). The patient holds the film in position with his thumb, keeping his other fingers out of the beam.



**FIGURE 4: FILM POSITIONING**  
**Bisecting technique**

□ **Paralleling technique:**

Place the film and generator as shown on figure 5 (the beam is perpendicular to the film). In this case, a film-holder should be used.

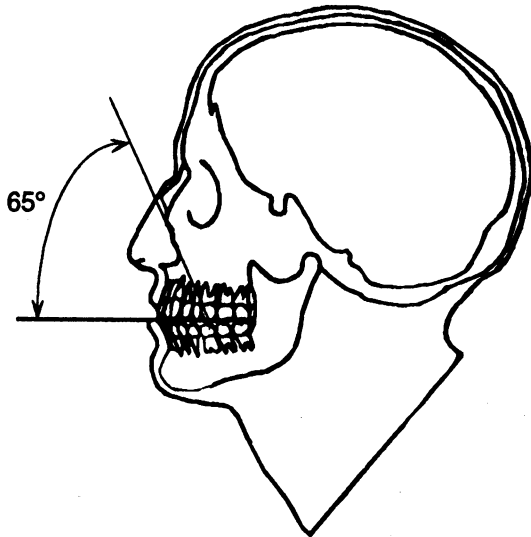


**FIGURE 5: FILM POSITIONING**

**Paralleling technique**

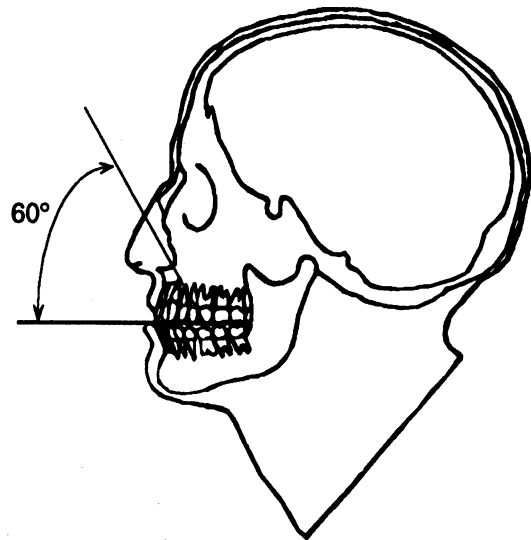
□ Occlusal films

INCISOR

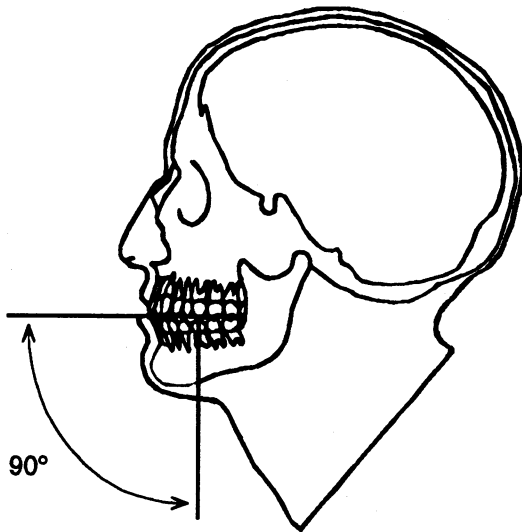


SUP

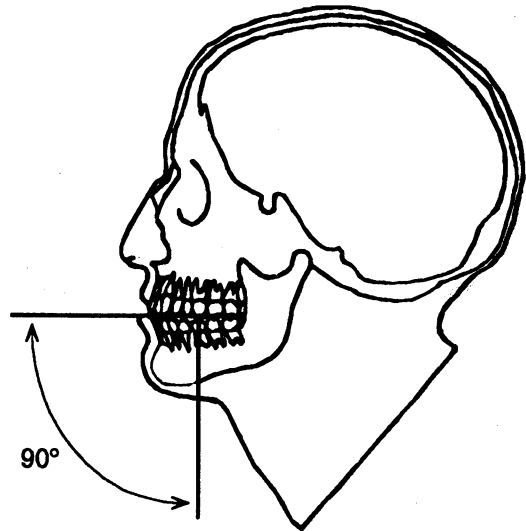
MOLAR



OCCLUSAL

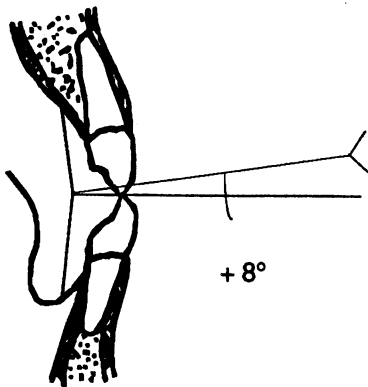


INF

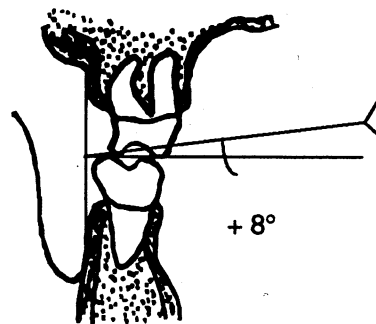


**FIGURE 6: FILM POSITIONING**  
*Occlusal pictures*

□ Bitewing films

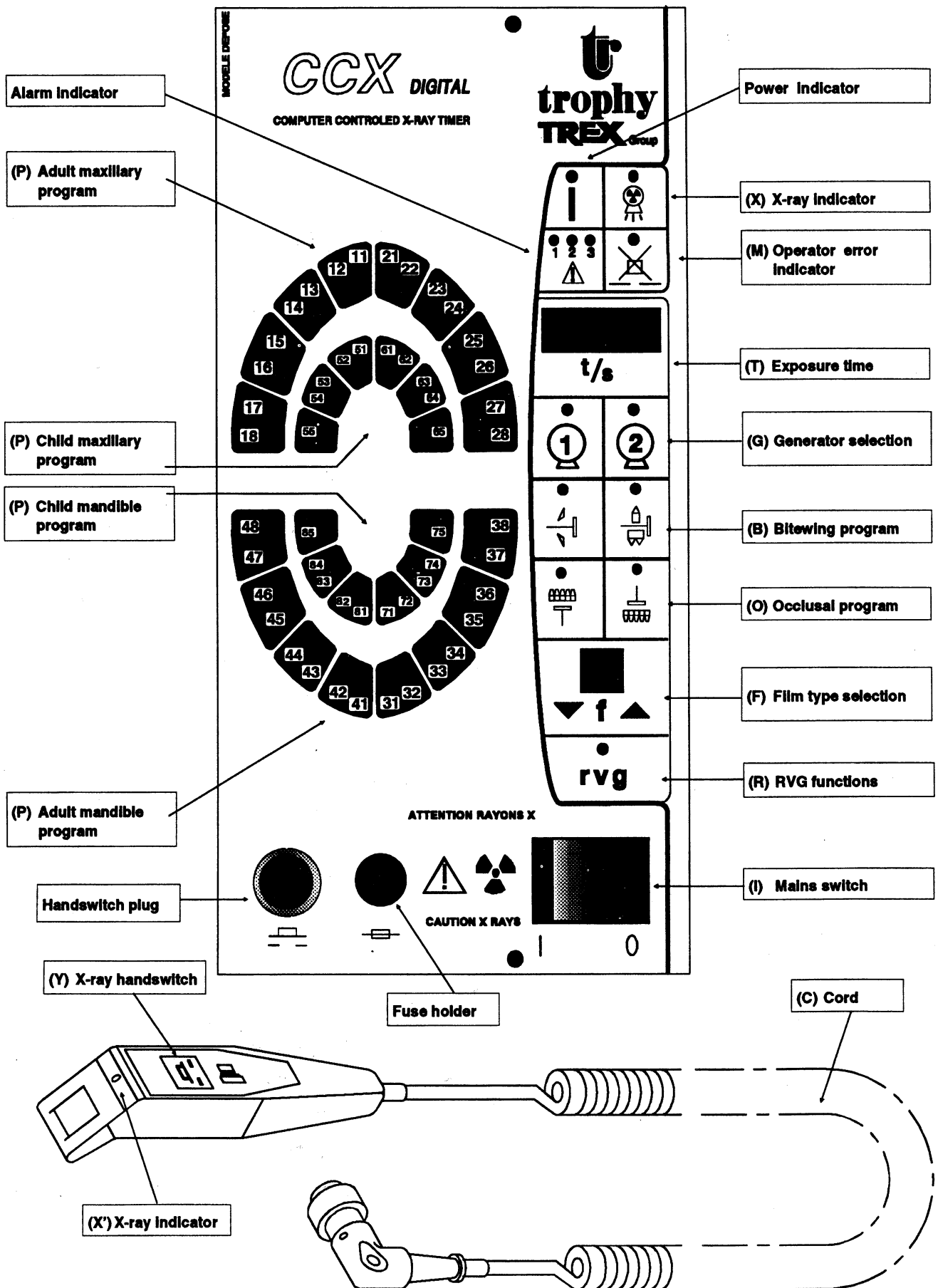


BITEWING



**FIGURE 7: FILM POSITIONING**  
*Bitewing pictures*

FIGURE 8: CCX-Digital TIMER



#### IV. PREPARING THE TIMER AND TAKING AN X-RAY

- ❑ Switch the timer on: the "power" indicator and the following come on:
  - > a selected tooth or special exposure and the corresponding exposure time
  - > the exposure mode (RVG or film)
  - > the generator selected (1 or 2)
  - > the type of film selected (1 to 9)
  
- ❑ Program the timer:
  - > select the generator to be used (key G)
  - > select the desired tooth (key P). This automatically selects the exposure time after compensation for the mains voltage; the time indicated may vary slightly if the mains voltage is not stable.
  - > select the exposure mode (RVG or film) to suit the peripheral equipment (key R):
    - Film: light off
    - RVG: light on
    - Other mode: light flashing
  - > Select the film type as indicated in table IV page 14 (key F). This selector can also be used to compensate for the patient's size:
    - Large patient: increase the film type
    - Small patient: reduce the film type
    - For the Australian version:
      - Press tooth keys 71/72 and 41/42 and increase film type key
      - or
      - Press tooth keys 81/82 and 43/44 and decrease film type key respectively
  
- ❑ Start the exposure:
  - > press the handswitch (Y): the X and X' indicators on the CCX-D and on the handswitch come on and a buzzer sounds.
  - > keep the handswitch depressed until X and X' indicators go out and the buzzer stops.

---

#### CAUTION:

An operator error (M) will be triggered if the handswitch is released before the end of the exposure. This indicates that the X-rays have been stopped prematurely and that your film will be underexposed. The digital display then indicates how much of the selected exposure time has not been used. The alarm can be stopped by reselecting a tooth on the timer.

---

## V. ADDITIONAL CHARACTERISTICS OF THE TIMER

- ❑ The timer automatically corrects the exposure time to allow for variations in mains voltage ( $\pm 20\%$ ). The image contrast is, therefore, correct even if the mains supply varies.
- ❑ The CCX-Digital timer includes a temperature safety device to prevent overheating the generator and thus to increase its life. This safety device imposes a certain rest period between two consecutive exposures, which is calculated from the last exposure parameters and the time elapsed between exposures.

In normal use, this security will be transparent to the user. The timer will only impose a rest period after long, repeated exposures (the tooth selected then flashes).

- ❑ The CCX-Digital timer displays a count-down of the exposure time while the X-ray is being taken.

If the exposure is interrupted (for example by releasing the handswitch), the operator error (visible and audible) is triggered and the remaining exposure time is displayed. This information helps decide whether to develop the film or immediately take another X-ray.

The operator error stops when a tooth is selected again.

- ❑ The timer includes a self-test function, activated as follows:
  - switch the timer off
  - press the RVG key and, at the same time, switch the timer on
  - release key RVG as soon as the tooth 41/42 lights up

All timer indicators are tested one after another except alarm number 3 and X-ray emission. The generator selection relay, audible alarm and digital displays are also tested.

At the start of the test, the unit displays the number of exposures taken since first being put into service, as follows:

- the film type display indicates the tens of thousands of exposures
- the exposure time display indicates the thousands, hundreds, and tens

example: "0 004" indicates between 40 and 50 exposures

"0 204" indicates between 2,040 and 2,050 exposures

"4 123" indicates between 41,230 and 41,240 exposures.

The total counter capacity is therefore 99,999 exposures.

# FILM DEVELOPMENT

---

## I. MANUAL DEVELOPMENT

Refer to the user manual of your film processor.

## II. AUTOMATIC DEVELOPMENT

Care must be taken in developing films to obtain good quality X-rays.

- ① Remove the film from its package in a darkroom, taking care to avoid fingerprints or nail marks.
- ② Dip in a developer bath and agitate slightly for a few seconds; leave it in the bath for 5 min at 20°C, 6 min at 18°C, or 4 min at 22°C.
- ③ Rinse it in running water for approx. 20 seconds.
- ④ Dip it in the fixer bath, agitating it for a few seconds and then leave it for at least 5 min in the bath.
- ⑤ Wash it in running water. Wash the film for quite some time to ensure it can be correctly conserved.
- ⑥ Allow it to dry in dry open air, protected from dust.

Steps ⑤ and ⑥ can be done in normal daylight.

It is important to use fresh baths with the correct concentration; do not add developer to increase the bath concentration, since this will increase the contrast but reduce sharpness.

## MAIN REASONS FOR POOR X-RAYS

FILM	Exposure time	Development time	Bath quality	Position
underexposed	too short	too short	too cold	
overexposed	too long	too long	too hot	
insuff. detail		too short	too cold or exhausted	
fuzzy				the patient moved
off-center				incorrect tubehead or film positioning

# TECHNICAL CHARACTERISTICS

## I. TECHNICAL CHARACTERISTICS ACCORDING TO IEC STANDARD 601-2-7

### Manufacturer

TROPHY RADIOLOGIE  
4, rue F. Pelloutier - Croissy-Beaubourg  
77437 MARNE-LA-VALLÉE CEDEX2 - FRANCE

### Models

Dental X-ray diagnosis devices, class 1, type B, intermittent use with protection against radiation risks according to IEC standard 601-1-3 (1994).

#### *IRIX 70*

### Electric power supply

Power absorbed 900 VA

230 - 240 V AC ( $\pm 10\%$ ), 50 Hz, 4 A, apparent resistance 0,5  $\Omega$

Permanent current 0.05 A

Current during X-ray emission 4 A

110 - 130 V AC ( $\pm 10\%$ ), 50/60 Hz, 8 A, apparent resistance 0,2  $\Omega$

Permanent current 0.1 A

Current during X-ray emission 8 A

Rated high voltage and maximum corresponding current 70 kV/8 mA

Current/voltage combinations for a maximum output power of 414 W

- with a form factor of .74 70 kV/8 mA

Rated power for exposure time of 0.1 s with 70 kV/8 mA 414 W

Reference time/voltage product

kV	mA	s	mAs
$\pm 10\%$	$\pm 15\%$	$\pm 10\%$	
70	8	0,1	0,8

### Rate of use

At 70 kV, 8 mA and 0.1 s and at the maximum tank temperature: one exposure every 13 seconds.

Minimum value of the current/time product in the range of conformity: 0.48 mAs at 8mA

### Applicable range of load parameters

Due to the mains frequency and for exposure times lower than 0.063 s, some values of the R'10 series do not exist. Mains variation compensation for these values is not correct.



**Area of conformity to the IEC standard 601-2-7**

- Reproducibility of the emitted radiation conform
- Linearity of the emitted radiation conform
- Precision in radiography conform

**Measurement conditions**

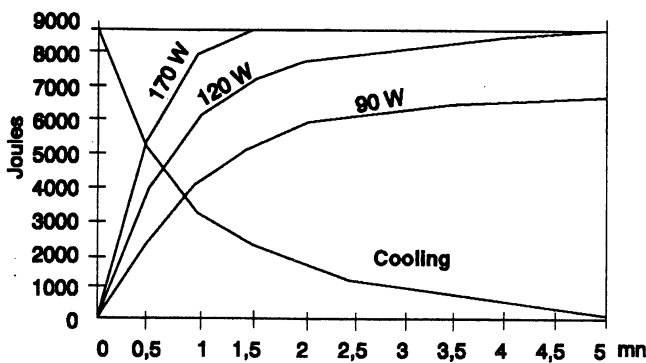
- kV: direct measurement using a peak kilovoltmeter
- mAs: direct measurement in the circuit using a mAsmeter
- Exposure time: measurement of the number of peak higher than 20% of the maximum dose current using a dosimeter

**Dimensions and weight**

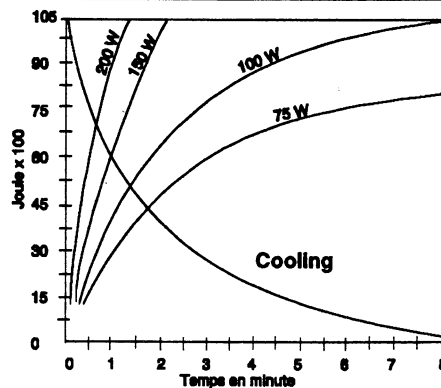
Timer unit	4-5/16 x 5-13/16 x 11-5/8 in. 110 x 145 x 295 mm	5.95 lb 2.7 kg
X-ray emitting unit	5-1/2 x 7-7/8 x 15-9/16 in. 140 x 200 x 395 mm	17.63 lb 8 kg
Scissor arm	2-3/8 x 5-5/8 x 34 in. 60 x 135 x 865 mm	26.45 lb 12 kg

**II. MAIN CHARACTERISTICS OF THE X-RAY GENERATOR according to standard EN 60601-2-28**

Manufacturer and type of X-ray tube	TROPHY Type TRX 708	CEI Type OCX / 65-G
Rated high voltage	70 kV	70 kV
Rated anodic power	490 W	490 W
Maximum heat accumulated in the anode	8 700 J	10 000 J
Rated value of focal spot (IEC 336/1982)	0.7 mm (.027 ")	0.7 mm (.027 ")
Target materials	Tungsten	Tungsten
Target slope	19 °	19 °
Filtration due to fixed materials	0.6 mm (.023 ") eq. Al	0.6 mm (.023 ") eq. Al



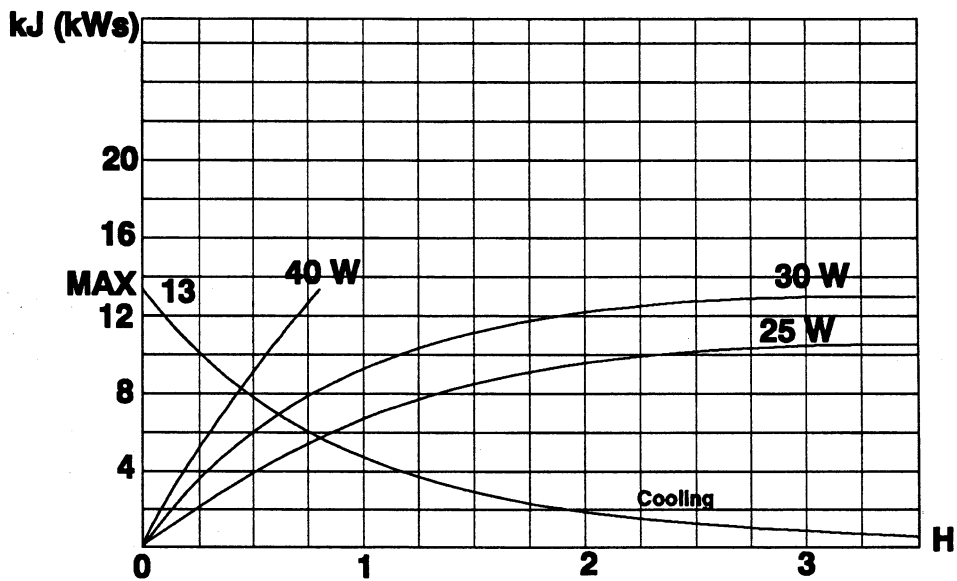
**TROPHY tube type TRX 708**



**CEI tube type OCX / 65-G**

**Equipped X-ray generator**

IEC standard 601-2-28	conform
Type of protection against electric shocks	Class I
Degree of protection against electric shocks	Type B
Rated value of inherent filtration at 70 kV	1.0 mm (.059 ") eq. Al
Rated value of additional filtration at 70 kV	1.5 mm (.039 ") eq. Al
Rated value of total filtration at 70 kV	2.5 mm (.098 ") eq. Al
Beam limiting cone, focal spot/skin distance	20 cm (7-7/8 in.)
Maximum accumulated heat	13,000 J
Maximum continuous thermal dissipation	30 W
Leaking radiation for a maximum rate of use at 414 W for one hour	< 0.25 mGy
Maximum field of symmetrical radiation	2-3/8 in. (6 cm) diameter
Safety thermal switch temperature	66 °C



**Heating and cooling curves of the X-ray tank**

### III. EXPOSURE TIMES FOR DIFFERENT PROGRAMS (film type 6 and nominal voltage)

PROGRAM	SELECTION	ANGLE	TIME (sec)
ADULT	42 - 41 - 31 - 32	- 15	.220
	44 - 43 - 33 - 34	- 20	.220
	46 - 45 - 35 - 36	- 10	.220
	48 - 47 - 37 - 38	- 5	.260
	12 - 11 - 21 - 22	+ 40	.260
	23 - 24 - 13 - 14	+ 45	.260
	25 - 26 - 15 - 16	+ 30	.340
	27 - 28 - 17 - 18	+ 30	.380
CHILD	82 - 81 - 71 - 72	- 15	.140
	83 - 84 - 73 - 74	- 20	.140
	85 - 75	- 10	.140
	52 - 51 - 61 - 62	+ 40	.180
	63 - 64 - 53 - 54	+ 45	.180
	55 - 65	+ 30	.220
BITEWING	canines-incisors	+8	.220
	molars	+8	.260
OCCLUSAL	maxillary		.600
	mandible		.600

## IV. CHOICE OF FILM TYPE

MANUFACTURER	MODEL	FILM TYPE
KODAK	Ekta Speed	3
KODAK	Ekta Speed Plus	3
AGFA	Dentus M4	3
DENTAL UNION	Bleu Star	3
AGFA	Dentus M2	5
AGFA	Normal	6
DUPONT	Lightning fast	6
GEVAERT	Dentus Ultra Rapid	6
KODAK	Ultra Speed	6
RINN	Super Fast	6
MINIMAX	Intermediate	8
RINN	Extra Fast	9

## V. FILM TYPE CORRECTION FACTORS

POSITION	VARIATION	FACTOR
0	- 73%	0.27
1	- 67 %	0.33
2	- 59 %	0.41
3	- 49 %	0.51
4	- 36 %	0.64
5	- 20 %	0.80
6	0	1
7	+ 25 %	1.25
8	+ 56 %	1.56
9	+ 95 %	1.95

## VI. TROUBLESHOOTING

SYMPTOM	CAUSE	CORRECTIVE ACTION
No lights come on	unit disconnected	connect the unit
	fuse blown	replace the fuse
	main switch "OFF"	set switch to "ON"
No X-rays emitted	the generator is cooling	wait for the selection light to stop flashing
	handswitch disconnected	connect the handswitch
	handswitch out of order	replace the handswitch
Exposure cycle OK, but film too light or too dark	incorrect film type	see film type selection table
	generator incorrectly positioned	position it correctly
	wrong exposure time	correct the exposure time
	development too short or too long	see instructions on development
	developer too cold or too warm	adjust temperature
	developer too old	change it
	RVG key incorrectly activated	switch to proper mode
	film back-to-front	see "film positioning" section
	incorrect installation	call in a service technician
Operator alarm with audible warning	handswitch released before exposure time elapsed	select a tooth to stop the alarm, then repeat the exposure
Alarm N°1, 2 or 3 and audible warning	microprocessor has detected a problem	call in a qualified technician

**⚠ The timer must be switched off to stop an N°1,2 or3 alarm.**

# PREVENTIVE MAINTENANCE

---

This unit has been designed to be easy to use and to provide maximum diagnostic capabilities.

To guarantee a correct and safety working of this unit, preventive maintenance has to be done on a first level every year and on a second level every two years.

It is the responsibility of the user to control the maintenance schedule.

Contact your authorized Trophy dental representative who will give you a maintenance certificate, dated and signed, with the detailed controls and repairs done.

## I. FIRST LEVEL MAINTENANCE - YEARLY

### ① Generator

- > check that the certification label is intact
- > check that there is no oil leakage
- > check that the beam limiting device is correctly attached to the generator and maintains a distance of at least 20 cm between focal spot and skin
- > check that the black plastic locking collar which attaches the generator to the arm is correctly positioned and the screw is tight (if incorrectly attached, the generator could fall and cause injury).

### ② Support and scissor arm

- > check that the wall bracket is securely attached to the wall (or ceiling, floor or unit as appropriate). Alternatively, check that the mobile stand on which it is mounted is stable.
- > check the scissor arm in all positions and adjust it if necessary
- > if your scissor arm is making any noise, call your TROPHY representative for a quick intervention
- > if the rotation of your generator is difficult, call your TROPHY representative for a quick intervention
- > For an installation with an extension arm of 31-1/2 in., check that the 360 ° rotation of the scissor is retracted by the stops mounted on the extension arm to prevent the cables being ripped out.

### ③ Timer

- > make sure the label is clearly visible
- > check the condition of the handswitch and its cord
- > Switch the timer on.
- > Check that the green "power" light comes on.
- > Select tooth 27-28 and type 5 film and then trigger exposure. Check that the "X-ray" light comes on during exposure, the counter automatically decrements to zero and the audible signal stops at the end of X-ray emission.
- > Trigger an exposure and check that the red "operator error" light comes on and that an audible signal, different to the previous signal, sounds when the handswitch button is released before the end of exposure since. In normal use, the handswitch button must be kept pressed until the end of the exposure.



### ④ Self-test

- > Switch the timer off.
- > Press RVG button and simultaneously switch the timer on. Wait for tooth 41-42 to lit before releasing the RVG button. All the timer functions and lights will automatically be tested (except the "X-ray" indicator light and alarm light no. 3 which indicates a microprocessor alarm; these functions are tested but the lights do not come on). A short audible signal is generated at the end of the test cycle.

If any of the lights or the audible signal does not work, contact your TROPHY representative.

### ⑤ Electrical installation

- > check that all grounding points are correctly connected
- > check that the main voltage is within the limits given in the installation manual

**☞ After completing this preventive procedure, check that your user's manual is available close to the unit.**

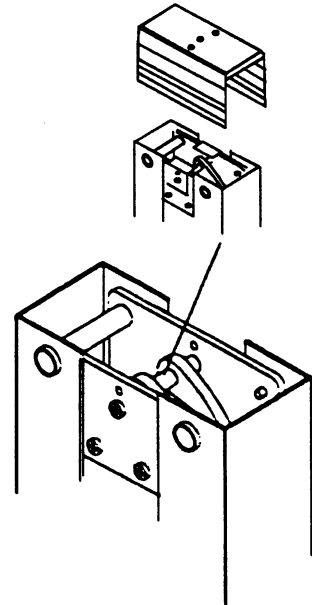
**☞ If the results of any of these checks are unsatisfactory, call a qualified technician from your TROPHY representative for corrective action. In the meantime, it is strongly recommended to not use the unit.**

## II. SECOND LEVEL MAINTENANCE - EVERY TWO YEARS

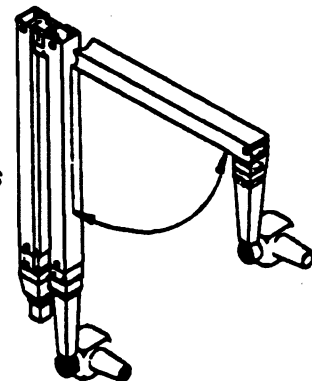
- ⚠ ***This maintenance must be done by a qualified technician from your authorized TROPHY distributor.***
- ⚠ ***If the results of any of these checks are unsatisfactory, call a qualified technician from your TROPHY representative for corrective action. In the meantime, it is strongly recommended to not use the unit.***

### ① Central axis wear check

- > Remove the central plastic cover.
- > Check that the axis does not roll when moving the arm as shown aside.
- > If the axis rolls or the movement is noisy, this is an indication of a wear which can cause the genetor to fall down.



- ⚠ ***An exchange of the complete arm has to be done as soon as possible.***



### ② Arm balance and spring tension

- > Check that the arm is flexible in all positions and that it remains immobile when no longer handled.
- > In case of problem, adjust the spring tension as requested.

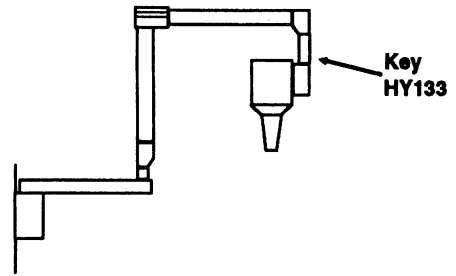


### ③ Generator rotating contact

- Set the arm as shown aside.

### ⚠ *Never use an other arm position.*

- Remove the plastic key HY133 fixing the generator on the arm.
- Remove the generator.



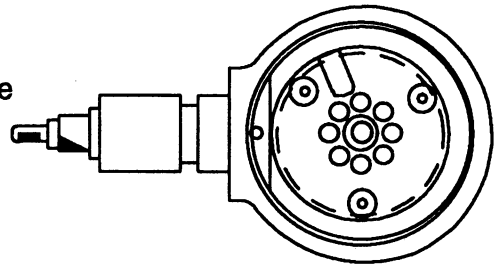
### ⚠ *If there is a problem when removing the generator, exchange the complete assembly arm and generator.*

- Using alcohol clean the contacts of the generator and its pivot.

- Check carefully the following:

**NOTE:** the black parts on the drawings indicate the concerned parts.

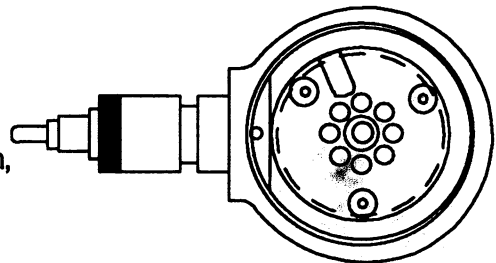
- Black marks on the contact



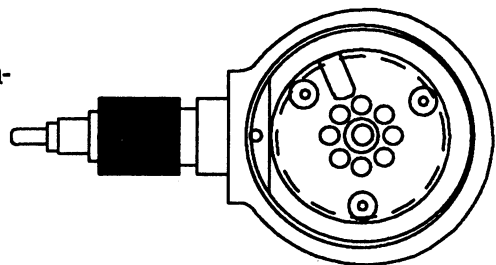
- Seizing marks on the pivot

- In case of seizing,

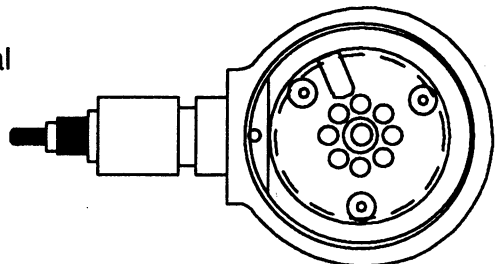
- Clean carefully using emery cloth, 180 grain, until the marks disappear.



- Slightly grease the pivot using high quality mechanical grease, WYNN's HP type.



- Slightly grease the contacts using a special 1,000 V grease.  
This grease is available from TROPHY.



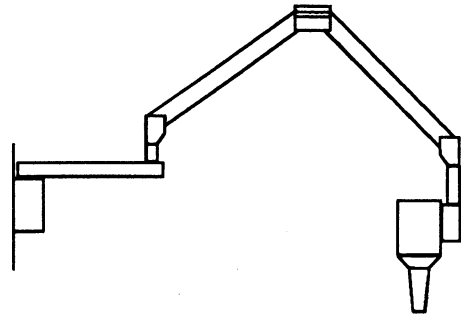
- Using alcohol clean carefully the inner part of the arm.
- Remount the generator. Carefully set the key.
- Check if the generator moves smoothly.

**④ Generator power supply cable**

- Check the cable for wears and tears, overall at the articulation points of the arm.
- In case of problem, change the cable.

**⑤ Extension arm's horizontality**

- Set the scissor arm in the position shown aside. The arm half extended must remain in the same position during its horizontal rotation movement
- In the same starting position, using a spirit level placed on the extension arm, check the arm's horizontality during its horizontal rotation.



**⚠ In case of problem, remove the generator and verify all the mounting procedure, see Installation and maintenance manual.**

**⑥ Wall bracket mounting**

- Placing and moving the arm in the worse conditions, fully extended and complete rotation, check that the wall bracket remains stable on the wall.

**⚠ In case of problem, remove the generator and verify all the mounting procedure, see Installation and maintenance manual.**

### III. FUSES EXCHANGE

- ❑ Switch off the timer and remove the main plug or switch off the main circuit breaker.

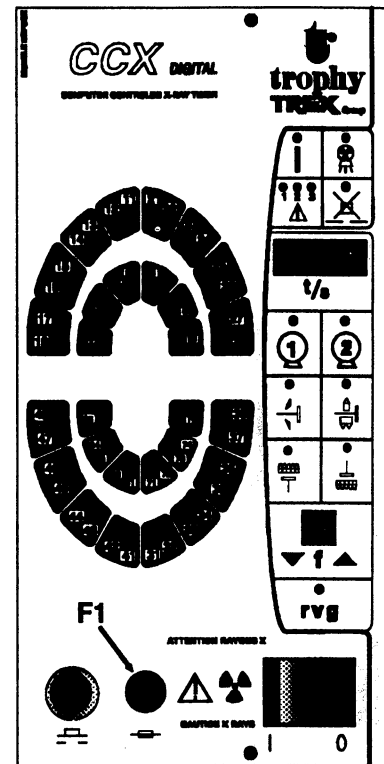
- ❑ **Timer front panel fuse F1**

Power circuits fuse

110 - 130 V : 10 A ; 6,3 x 32

230 - 240 V : 6.3 A ; 5x20

- Using a screwdriver, remove the fuse cap.
- Remove the defective fuse.
- Insert a new fuse, exactly the same type.
- Screw again the fuse cap.



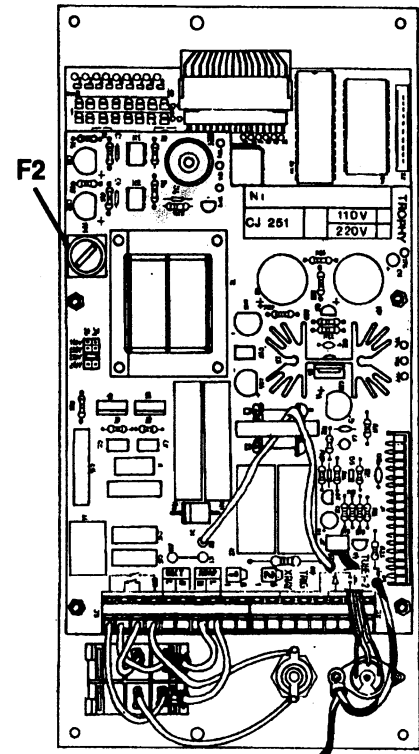
- ❑ **CJ251 PCB fuse F2**

Control circuits fuse

110 - 130 V : 250 mA ; 5 x20

230 - 240 V : 130 mA ; 5x20

- Remove the cover of the wall bracket using an Allen key 3 mm (.12 in.)
- The fuse is located on the board.
- Using a screwdriver, remove the fuse cap.
- Remove the defective fuse.
- Insert a new fuse, exactly the same type.
- Screw again the fuse cap.
- Remount the wall bracket cover



# NOTES










4, rue F. Pelloutier - Croissy-Beaubourg  
77437 MARNE-LA-VALLÉE Cédex 2 FRANCE  
Ph. : + 33 1 64 80 85 00 - Fax : + 33 1 64 80 85 85  
Site Internet : <http://www.trophy-imaging.com>  
E-mail : [customer-service@trophy-imaging.com](mailto:customer-service@trophy-imaging.com)

TROPHY BÉNÉLUX	30, avenue des Nymphes - Centre Cial Les Dauphins B 1410 - WATERLOO Ph. : + 32 2 354 15 28 / 68 74 - Fax : + 32 2 353 04 60
TROPHY ESPAÑA S.L.	Calle Pilar de Zaragoza, 15 28028 MADRID Ph. : + 34 91 355 88 09 - Fax : + 34 91 356 89 82
TROPHY GERMANY GmbH	Gerbereistr. 7 D 77694 KEHL-KORK RHEIN - GERMANY Ph. : + 49 78 51 93 970 - Fax : + 49 78 51 939 730
TROPHY ITALIA spa	Via Guarenti, 4 20035 - LISSONE (MI) Ph. : + 39 39 27 80 864 / 877 - Fax : + 39 39 27 80 889
TROPHY RADIOLOGY (UK) Ltd	Unit 3, Block B, Connaught, Business Centre 9, Malham Rd, Forrest Hill LONDON, S.E. 23 1AH/UK Ph. : + 44 1 81 291 99 09 - Fax : + 44 1 81 291 98 00
TREX TROPHY DENTAL DIVISION	37 Apple Ridge Road DANBURY, CT 06810 USA Ph. : + 1 203 207 - 45 45 - Fax : + 1 203 207 - 45 46
TROPHY JAPAN	TOKYO-TO MINATO-KU Toranomom 1-23-7 Toranomom 23 Mori Building JAPAN Ph. : + 81 3 35 80 68 81 - Fax : + 81 3 35 80 68 83

The IRIX 70 is a  device  
**0459**

TROPHY S.A. is an ISO9001 - EN46001 company